

ISL85033DUALEVAL1Z Wide VIN Dual Standard Buck Regulator With 3A/3A Output Current

Description

The ISL85033DUALEVAL1Z kit is intended for use by individuals with requirements for Point-of-Load applications sourcing from 4.5V to 28V. The ISL85033DUALEVAL1Z evaluation board is used to demonstrate the performance of the ISL85033 wide VIN dual standard buck regulator with 3A/3A output current converter.

The ISL85033 is offered in a 4mmx4mm 28 Ld TQFN package with 1mm maximum height. The complete converter occupies 6.25cm² area.

Key Features

- Wide Input Voltage Range from 4.5V to 28V
- Adjustable Output Voltage with Continuous Output Current up to 3A
- Current Mode Control
- Adjustable Switching Frequency from 300kHz to 2MHz
- Independent Power-Good Detection
- Selectable In-Phase or Out-of-Phase PWMs Switching Operation
- Independent, Sequential, Ratiometric or Absolute Tracking Between Outputs
- Internal 2ms Soft-start Time
- Overcurrent and Hiccup Mode Short Circuit Protection, Thermal Overload Protection, UVLO
- Boot Undervoltage Detection
- Channels are Out-of-phase, Reducing Voltage Ripple and Component Size

Recommended Equipment

The following materials are recommended to perform testing:

- 0V to 30V Power Supply with at least 7A source current capability or 5V battery
- Electronic Loads capable of sinking current up to 7A
- Digital Multimeters (DMMs)
- 100MHz quad-trace oscilloscope
- Signal generator

Quick Setup Guide

1. Ensure that the circuit is correctly connected to the supply and loads prior to applying any power.
2. Connect the bias supply to VIN1, the plus terminal to VIN1 and the negative return to GND2.
3. Verify that the position is ON for S1 and S2.
4. Turn on the power supply.
5. Verify the output voltage is 5V for V_{OUT1} and 3.3V for V_{OUT2}.

Evaluating the Other Output Voltage

The ISL85033DUALEVAL1Z kit outputs are preset to 5V for V_{OUT1} and 3.3V for V_{OUT2}; however, output voltages can be adjusted from 0.8V to 5V. The output voltage programming resistor, R3 (or R14 in Channel 2), will depend on the desired output voltage of the regulator and the value for the feedback resistor R2 (R16 respectively), as shown in Equation 1.

$$R3 = (V_{OUT1} - V_{FB}) \cdot R2 / V_{FB} \quad (\text{EQ. 1})$$

$$R14 = (V_{OUT2} - V_{FB}) \cdot R16 / V_{FB}$$

If the output voltage desired is 0.8V, then R3 (R14 respectively) is shorted. The value for R2 (R16 respectively) is typically between 1k and 10k. Please note that if V_{OUT} is less than 2.5V, the switching frequency and compensation must be changed for 300kHz operation due to minimum on-time limitation. Please refer to the data sheet for further information ([FN6676](#)).

Frequency Control

ISL85033 has an FS pin that controls the frequency of operation. Programmable frequency allows for optimization between efficiency and external component size. Default switching frequency is 500kHz when FS is tied to VCC (R9 = 0). By removing R9 and connecting R10 to ground, the switching frequency could be changed from 300kHz (R10 = 383k) to 2MHz (R10 = 40.2k). Please refer to the data sheet ([FN6676](#)) for calculating the value of R10. Do not leave this pin floating.

Disabling/enabling Function

The ISL85033 evaluation board contains S1, S2 switches to enable or disable each of the channels, thus allowing low quiescent current state. Table 1 details this function.

TABLE 1. SWITCH SETTINGS

S1	S2	ON/OFF CONTROL
ON	OFF	Enable V _{OUT1} ; Disable V _{OUT2}
OFF	ON	Disable V _{OUT1} ; Enable V _{OUT2}
ON	ON	Enable V _{OUT1} ; Enable V _{OUT2}
OFF	OFF	Disable V _{OUT1} ; Disable V _{OUT2}

If EN1 or EN2 are floating, then the outputs will start in the sequencing described in the data sheet section on output sequencing and also summarized in Table 2.

TABLE 2.

EN1	EN2	V _{OUT1}	V _{OUT2}	NOTE
High	Floating	First	After V _{OUT1} > 90%	
Floating	High	After V _{OUT2} > 90%	First	
High	High	Same time as V _{OUT2}	Same time as V _{OUT1}	
Floating	Floating			Not Allowed

SYNC Control

The ISL85033 evaluation board has an SI pin that allows external synchronization frequency to be applied. Default board configuration has R18 = 0 to GND, which defaults to the internal selected switching frequency. Removing R18 allows the synchronization to be external between 600kHz to 4MHz. Do not leave this pin floating.

ISL85033DUALEVAL1Z Schematic

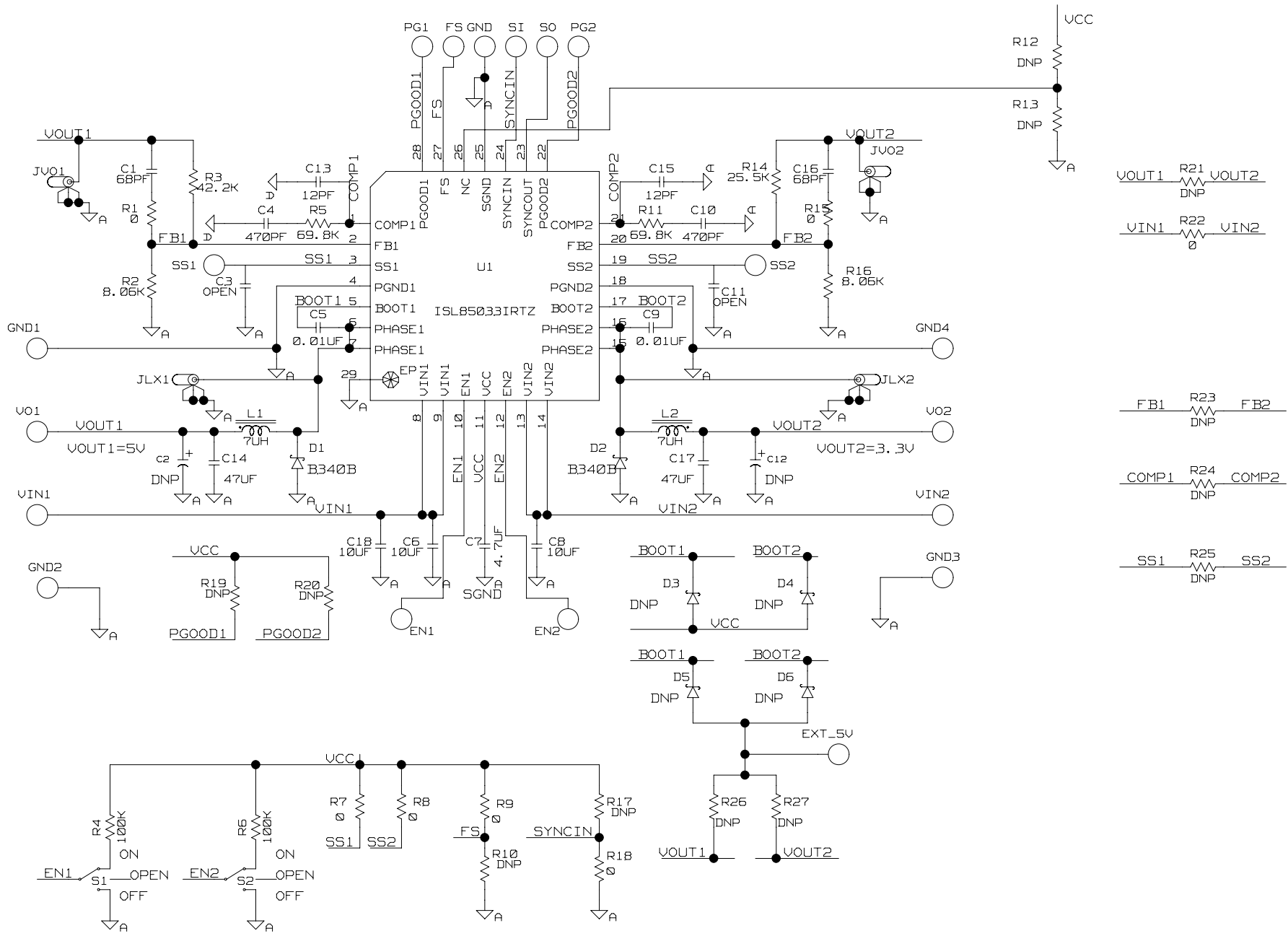

Application Note 1574

TABLE 3. BILL OF MATERIALS

PART NUMBER	QTY	UNITS	REFERENCE DESIGNATOR	DESCRIPTION	MANUFACTURER	MANUFACTURER PART #
ISL85033EVAL1ZREVBPCB	1	ea	SEE LABEL-RENAME BOARD	PWB-PCB, ISL85033EVAL1Z, REVB, ROHS	TBD	ISL85033EVAL1ZREVBPCB
EEE-FK1V101P-T	0	ea	DNP (C2, C12)	CAP, SMD, 8X10.2, 100µF, 35V, 20%, AL.EL., ROHS	PANASONIC	EEE-FK1V101P
GMK325BJ106KN-T	2	ea	C6, C8	CAP, SMD, 1210, 10µF, 35V, 10%, X5R, ROHS	TAIYO YUDEN	GMK325BJ106KN-T
H1044-00120-50V5-T	2	ea	C13, C15	CAP, SMD, 0402, 12pF, 50V, 5%, NPO, ROHS	AVX	04025C120JAT
					VENKEL	C0402COG500-120JNE
H1044-00680-50V5-T	2	ea	C1, C16	CAP, SMD, 0402, 68pF, 50V, 5%, NPO, ROHS	MURATA	GRM36COG680J050AQ
					PANASONIC	ECJ-0EC1H680J
					VENKEL	C0402COG500-680JNE
H1045-00103-50V10-T	2	ea	C5, C9	CAP, SMD, 0603, 0.01µF, 50V, 10%, X7R, ROHS	MURATA	GRM39X7R103K050
					AVX	06035C103KAT2A
					VENKEL	C0603X74500-103KNE
H1045-00471-50V5-T	2	ea	C4, C10	CAP, SMD, 0603, 470pF, 50V, 5%, NPO, ROHS	PANASONIC	ECJ-1VC1H471J
					VENKEL	C0603COG500-471JNE
H1045-00475-6R3V10-T	1	ea	C7	CAP, SMD, 0603, 4.7µF, 6.3V, 10%, X5R, ROHS	VENKEL	C0603X5R6R3-475KNE
					TDK	C1608X5R0J475K
					PANASONIC	ECJ-1VB0J475K
					MURATA	GRM188R60J475KE19D
					KEMET	C0603C475K9PACTU
					TAIYO YUDEN	JMK107BJ475KA-T
H1045-DNP	0	ea	C3, C11	CAP, SMD, 0603, DNP-PLACE HOLDER, ROHS		
H1082-00106-50V10-T	1	ea	C18	CAP, SMD, 1210, 10µF, 50V, 10%, X5R, ROHS	TAIYO YUDEN	UMK325BJ106KM-T
H1082-00476-16V20-T	2	ea	C14, C17	CAP, SMD, 1210, 47µF, 16V, 20%, X5R, ROHS	TDK	C3225X5R1C476M
					PANASONIC	ECJ-4YB1C476M
					MURATA	GRM32ER61C476ME15L
					TAIYO YUDEN	EMK325BJ476MM-T
					KEMET	C1210C476M4PACTU
					VENKEL	C1210X5R160-476MNE
SQL004	2	ea	L1, L2	COIL-PWR INDUCTOR, SMD, 10mm, 7µH, 25%, 4.8A, ROHS	FALCO	SQL004
131-4353-00	4	ea	JLX1, JLX2, JVO1, JVO2	CONN-SCOPE PROBE TEST PT, COMPACT, PCB MNT, ROHS	TEKTRONIX	131-4353-00

Application Note 1574

TABLE 3. BILL OF MATERIALS (Continued)

PART NUMBER	QTY	UNITS	REFERENCE DESIGNATOR	DESCRIPTION	MANUFACTURER	MANUFACTURER PART #
1514-2	8	ea	VO1, VO2, GND1-GND4, VIN1, VIN2	CONN-TURRET, TERMINAL POST, TH, ROHS	KEystone	1514-2
5002	11	ea	a) FS, SI, SO, EN1, EN2, GND, PG1, PG2	CONN-MINI TEST POINT, VERTICAL, WHITE, ROHS	KEystone	5002
5002	0	ea	b) SS1, SS2, EXT_5V	CONN-MINI TEST POINT, VERTICAL, WHITE, ROHS	KEystone	5002
B340B-13-F-T	2	ea	D1, D2	DIODE-SCHOTTKY, SMD, SMB, 2P, 40V, 3A, ROHS	DIODES INC.	B340B-13-F
ISL85033IRTZ	1	ea	U1	IC-3A DUAL STD REGULATOR, 28P, TQFN, 4x4, ROHS	INTERSIL	ISL85033IRTZ
H2505-DNP	0	ea	R10, R17, R19, R20, R23-R27	RESISTOR, SMD, 0603, 0.1%, MF, DNP-PLACE HOLDER		
H2510-00R00-1/16W-T	2	ea	R1, R15	RES, SMD, 0402, 0Ω, 1/16W, 5%, TF, ROHS	VENKEL	CR0402-16W-00T
					PANASONIC	ERJ-2GE0JR00
H2510-02552-1/16W1-T	1	ea	R14	RES,SMD, 0402, 25.5k, 1/16W, 1%, TF, ROHS	VENKEL	CR0402-16W-2552FT
					PANASONIC	ERJ-2RKF2552X
					VISHAY/DALE	CRCW040225K5FKED
					STACKPOLE	RMC 1/16S 25.5K 1% R
H2510-04222-1/16W1-T	1	ea	R3	RES,SMD, 0402, 42.2k, 1/16W, 1%, TF, ROHS	PANASONIC	ERJ-2RKF4222X
					VENKEL	CR0402-16W-4222FT
H2510-08061-1/16W1-T	2	ea	R2, R16	RES, SMD, 0402, 8.06k, 1/16W, 1%, TF, ROHS	VENKEL	CR0402-16W-8061FT
					PANASONIC	ERJ-2RKF8061X
					ROHM	MCR01MZPF8061
					YAGEO	RC0402FR-078K06L
					VISHAY/DALE	CRCW04028K06FKED
H2511-00R00-1/10W-T	4	ea	R7-R9, R18	RES, SMD, 0603, 0Ω, 1/10W, TF, ROHS	VENKEL	CR0603-10W-000T
					ROHM	MCR03EZPJ000
					PANASONIC	ERJ-3GEY0R00V
					YAGEO	RC0603JR-070RL
					VISHAY/DALE	CRCW06030000Z0EA
H2511-01004-1/10W1-T	2	ea	R4, R6	RES, SMD, 0603, 1M, 1/10W, 1%, TF, ROHS	PANASONIC	ERJ-3EKF1004V
					VENKEL	CR0603-10W-1004FT
					YAGEO	RC0603FR-071ML
					ROHM	MCR03EZPFX1004
					KOA	RK73H1JTDD1004F
					VISHAY/DALE	CRCW06031M00FKEA

Application Note 1574

TABLE 3. BILL OF MATERIALS (Continued)

PART NUMBER	QTY	UNITS	REFERENCE DESIGNATOR	DESCRIPTION	MANUFACTURER	MANUFACTURER PART #
H2511-06982-1/10W1-T	2	ea	R5, R11	RES, SMD, 0603, 69.8k, 1/10W, 1%, TF, ROHS	VENKEL	CR0603-10W-6982FT
					YAGEO	RC0603FR-0769K8L
					VISHAY/DALE	CRCW060369K8FKEA
					KOA	RK73H1JTDD6982F
H2511-DNP	0	ea	R12, R13	RES, SMD, 0603, DNP-PLACE HOLDER, ROHS		
H2514-00R00-1/4W-T	1	ea	R22	RES, SMD, 1210, 0Ω, 1/4W, TF, ROHS	VENKEL	CR1210-4W-000
H2514-DNP	0	ea	R21	RES, SMD, 1210, DNP, DNP, DNP, TF, ROHS		
GT13MCBE	2	ea	S1, S2	SWITCH-TOGGLE, THRU-HOLE, 5PIN, SPDT, 3POS, ON-OFF-ON, ROHS	C&K COMPONENTS	GT13MCBE
SJ-5003-BLACK	4	ea	Bottom four corners	BUMPONS, 0.44' W x 0.20' H, DOMETOP, BLACK	3M	SJ-5003SPBL
5X8-STATIC-BAG	1	ea	Place assy in bag	BAG, STATIC, 5X8, ZIPLOC, ROHS	INTERSIL	212403-013
DNP	0	ea	D3-D6	DO NOT POPULATE OR PURCHASE		
LABEL-RENAME BOARD	1	ea	RENAME PCB TO: ISL85033DUALEVAL1Z	LABEL, TO RENAME BOARD	INTERSIL	LABEL-RENAME BOARD
LABEL-SERIAL NUMBER	1	ea		LABEL, FOR SERIAL NUMBER AND BOM REV #		

ISL85033DUALEVAL1Z Board Layout

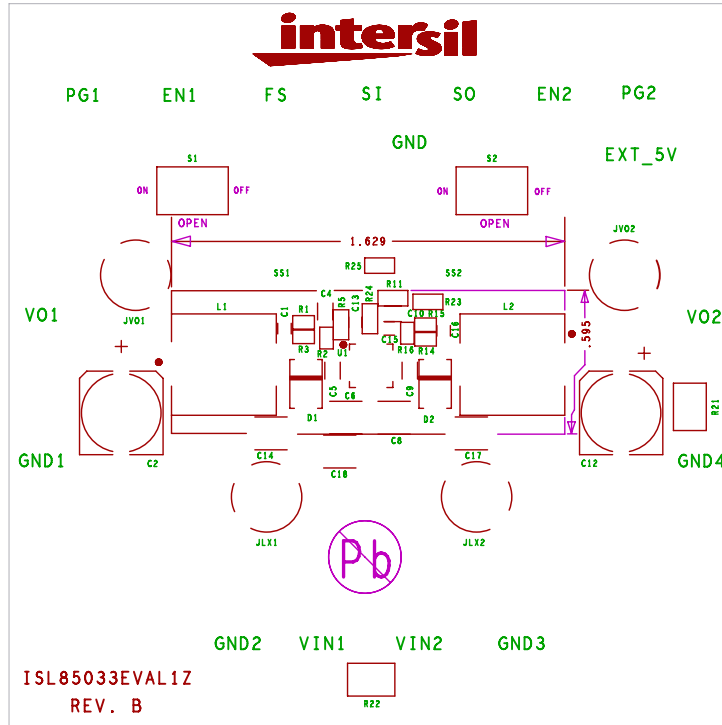

FIGURE 1. TOP LAYER COMPONENTS

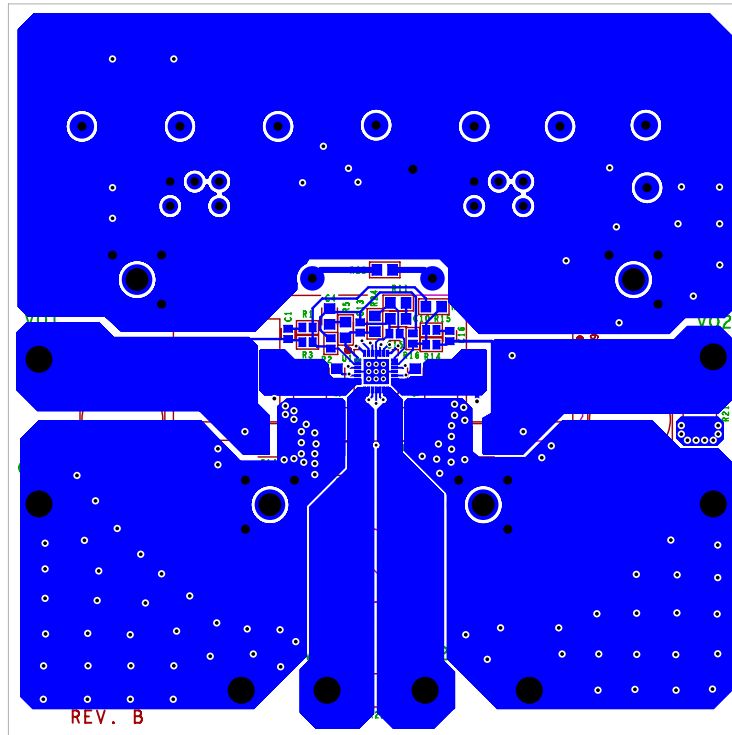

FIGURE 2. TOP LAYER ETCH

ISL85033DUAL1Z Board Layout (Continued)

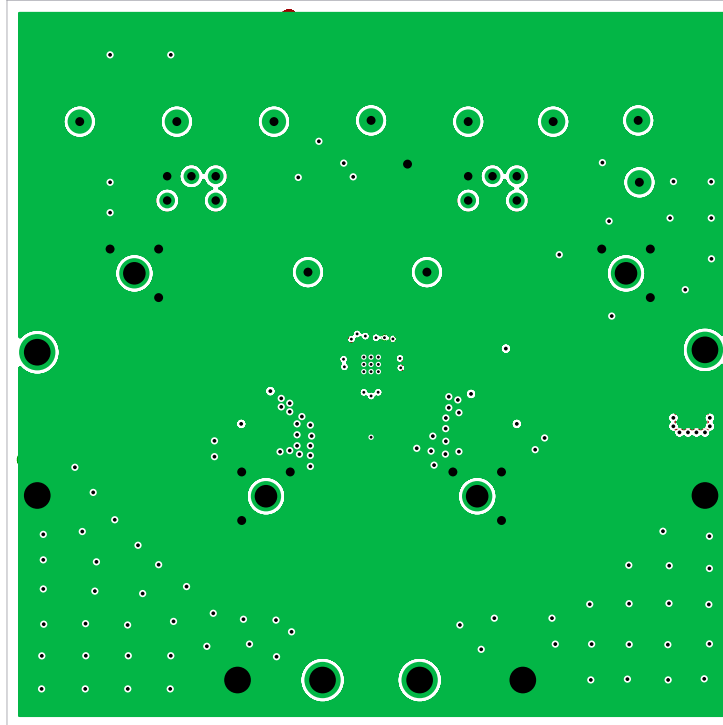

FIGURE 3. SECOND LAYER ETCH

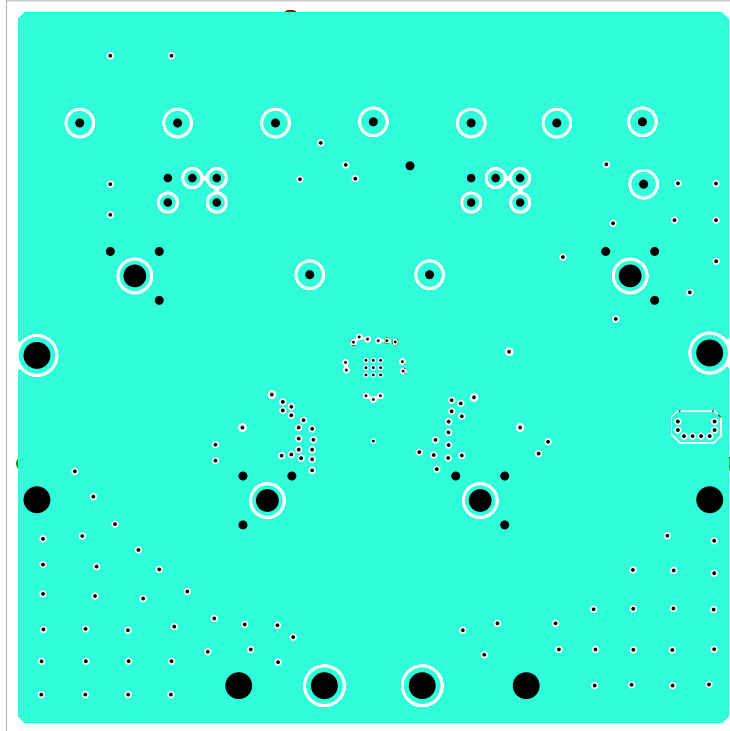

FIGURE 4. THIRD LAYER ETCH

ISL85033DUAL1Z Board Layout (Continued)

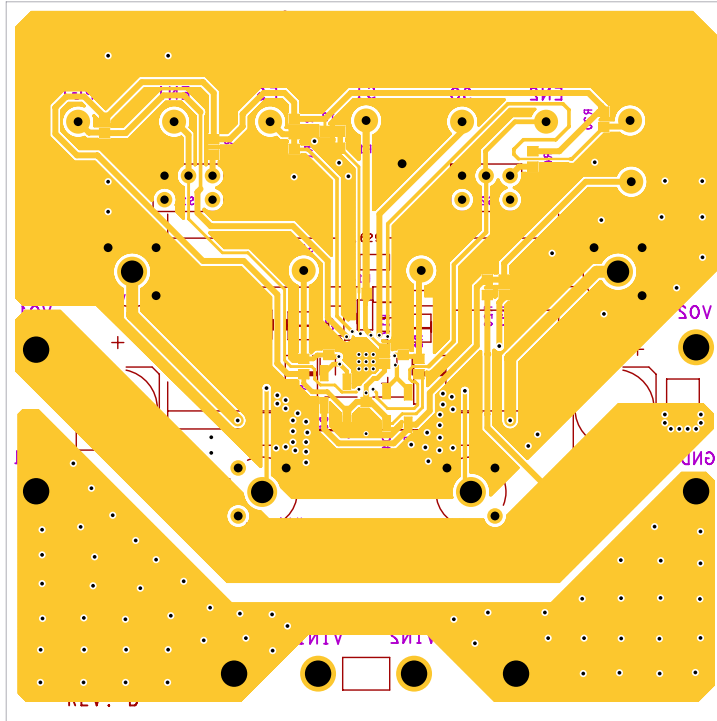

FIGURE 5. BOTTOM LAYER ETCH

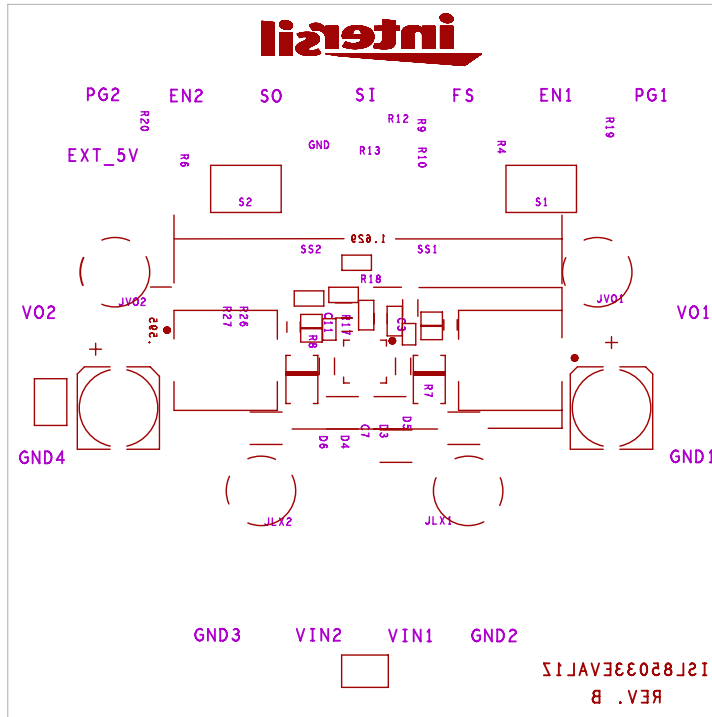

FIGURE 6. BOTTOM LAYER COMPONENTS

Intersil Corporation reserves the right to make changes in circuit design, software and/or specifications at any time without notice. Accordingly, the reader is cautioned to verify that the Application Note or Technical Brief is current before proceeding.

For information regarding Intersil Corporation and its products, see www.intersil.com