

NOTES

MATERIAL - DIECAST ALUMINUM ALLOY
 - FOUR M14 CAPTIVE SCREWS

POWDER COATED-COL. RAL 7032
 GASKET - POLYURATHANE
 -40°C TO +80°C TEMP. RANGE

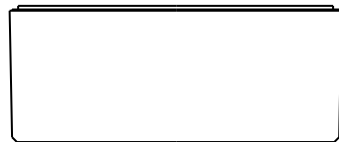
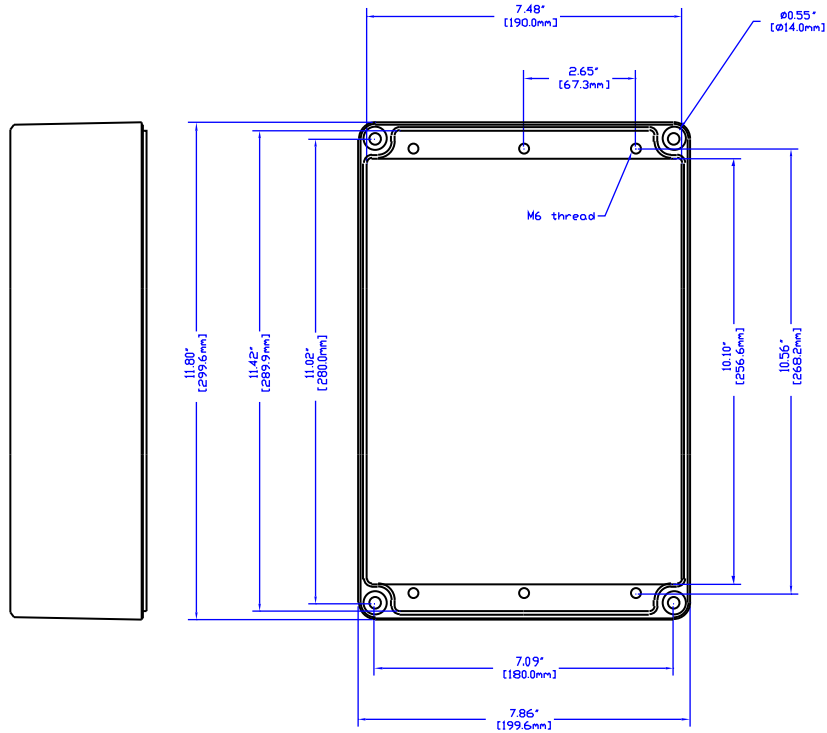
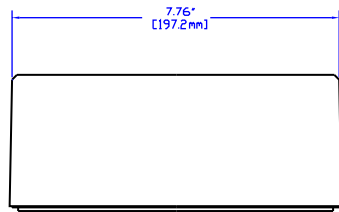

VIEW OF BOX (LID REMOVED)

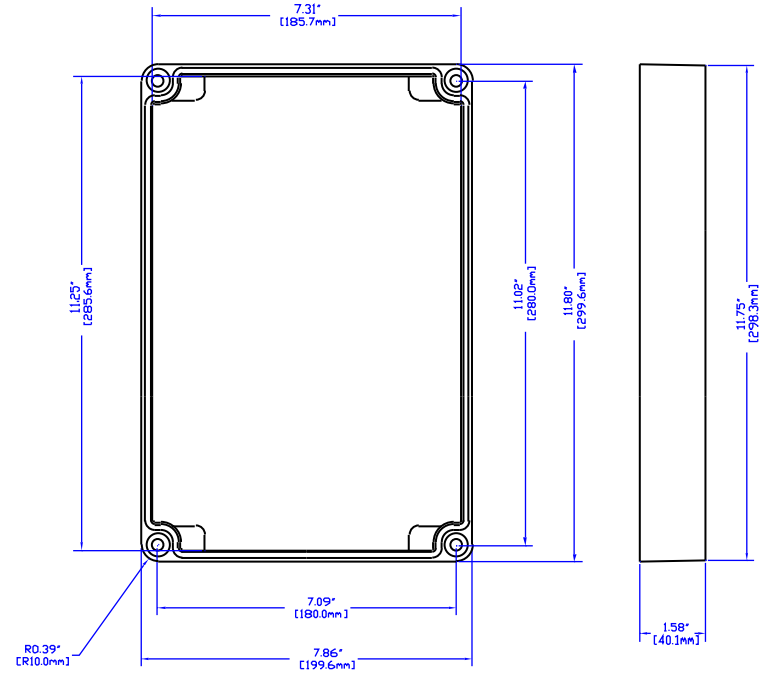
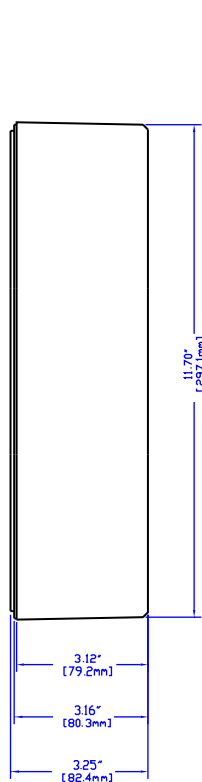

VIEW OF LID (INSIDE)



HAMMOND MANUFACTURING

R100-202-000

CANADA - PH (519) 886 7170 - FAX (519) 886 8311
 U.S.A. - PH (716) 631 5700 - FAX (716) 631 1156