

H11A1X, H11A2X, H11A3X, H11A4X, H11A5X
H11A1, H11A2, H11A3, H11A4, H11A5



ISOCOM
COMPONENTS

**OPTICALLY COUPLED
ISOLATOR
PHOTOTRANSISTOR OUTPUT**



APPROVALS

- UL recognised, File No. E91231
Package Code " GG "

'X' SPECIFICATION APPROVALS

- VDE 0884 in 3 available lead form : -
- STD
- G form
- SMD approved to CECC 00802
- H11A1-4 Certified to EN60950 by :-
Nemko - Certificate No. P01102464

DESCRIPTION

The H11A series of optically coupled isolators consist of infrared light emitting diode and NPN silicon photo transistor in a standard 6 pin dual in line plastic package.

FEATURES

- Options :-
10mm lead spread - add G after part no.
Surface mount - add SM after part no.
Tape&reel - add SMT&R after part no.
- High Isolation Voltage (5.3kV_{RMS}, 7.5kV_{PK})
- All electrical parameters 100% tested
- Custom electrical selections available

APPLICATIONS

- DC motor controllers
- Industrial systems controllers
- Measuring instruments
- Signal transmission between systems of different potentials and impedances

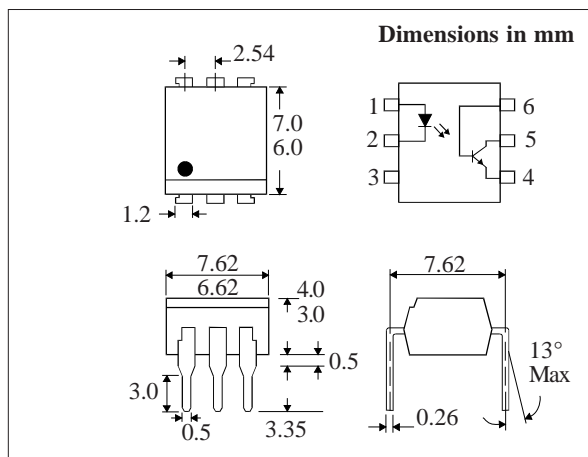

**ABSOLUTE MAXIMUM RATINGS
(25°C unless otherwise specified)**

Storage Temperature _____ -55°C to +150°C
Operating Temperature _____ -55°C to +100°C
Lead Soldering Temperature
(1/16 inch (1.6mm) from case for 10 secs) 260°C

INPUT DIODE

Forward Current _____ 60mA
Reverse Voltage _____ 6V
Power Dissipation _____ 105mW

OUTPUT TRANSISTOR

Collector-emitter Voltage BV_{CEO} _____ 30V
Collector-base Voltage BV_{CBO} _____ 70V
Emitter-collector Voltage BV_{ECO} _____ 6V
Collector Current _____ 50mA
Power Dissipation _____ 160mW

POWER DISSIPATION

Total Power Dissipation _____ 200mW
(derate linearly 2.67mW/°C above 25°C)

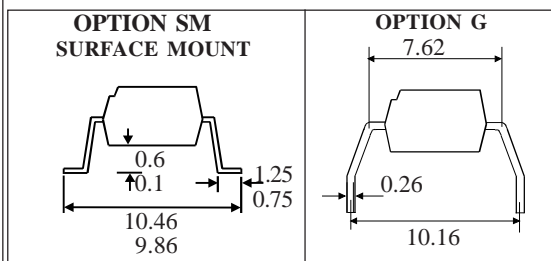

ISOCOM COMPONENTS 2004 LTD
Unit 25B, Park View Road West,
Park View Industrial Estate, Brenda Road
Hartlepool, TS25 1UD England
Tel: (01429)863609 Fax: (01429)863581 e-mail
sales@isocom.co.uk http://www.isocom.com

ELECTRICAL CHARACTERISTICS ($T_A = 25^\circ\text{C}$ Unless otherwise noted)

PARAMETER		MIN	TYP	MAX	UNITS	TEST CONDITION
Input	Forward Voltage (V_F)		1.2	1.5	V	$I_F = 10\text{mA}$
	Reverse Current (I_R)			10	μA	$V_R = 6\text{V}$
Output	Collector-emitter Breakdown (BV_{CEO}) (note 2)	30			V	$I_C = 1\text{mA}$
	Collector-base Breakdown (BV_{CBO})	70			V	$I_C = 100\mu\text{A}$
	Emitter-collector Breakdown (BV_{ECO})	6			V	$I_E = 100\mu\text{A}$
	Collector-emitter Dark Current (I_{CEO})			50	nA	$V_{CE} = 10\text{V}$
Coupled	Current Transfer Ratio (CTR)					
	H11A1	50			%	$10\text{mA } I_F, 10\text{V } V_{CE}$
	H11A2	20			%	$10\text{mA } I_F, 10\text{V } V_{CE}$
	H11A3	20			%	$10\text{mA } I_F, 10\text{V } V_{CE}$
	H11A4	10			%	$10\text{mA } I_F, 10\text{V } V_{CE}$
	H11A5	30			%	$10\text{mA } I_F, 10\text{V } V_{CE}$
	Collector-emitter Saturation Voltage $V_{CE(SAT)}$			0.4	V	$10\text{mA } I_F, 0.5\text{mA } I_C$
	Input to Output Isolation Voltage V_{ISO}	5300 7500			V_{RMS} V_{PK}	See note 1 See note 1
Input-output Isolation Resistance R_{ISO}	5×10^{10}			Ω	$V_{IO} = 500\text{V}$ (note 1)	
Output Rise Time tr		2		μs	$V_{CC} = 5\text{V}, I_F = 10\text{mA}$	
Output Fall Time tf		2		μs	$R_L = 75\Omega$ fig 1	

Note 1 Measured with input leads shorted together and output leads shorted together.
 Note 2 Special Selections are available on request. Please consult the factory.

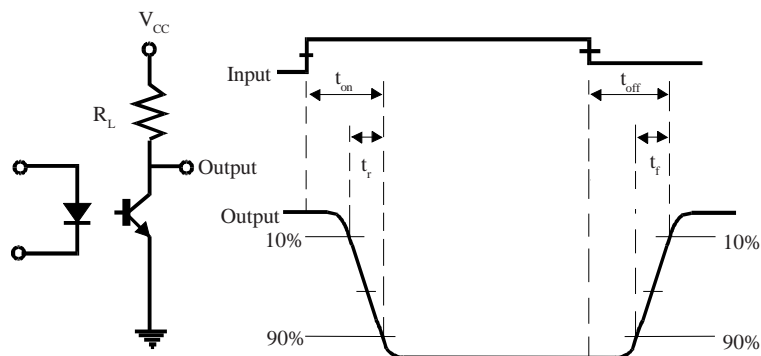
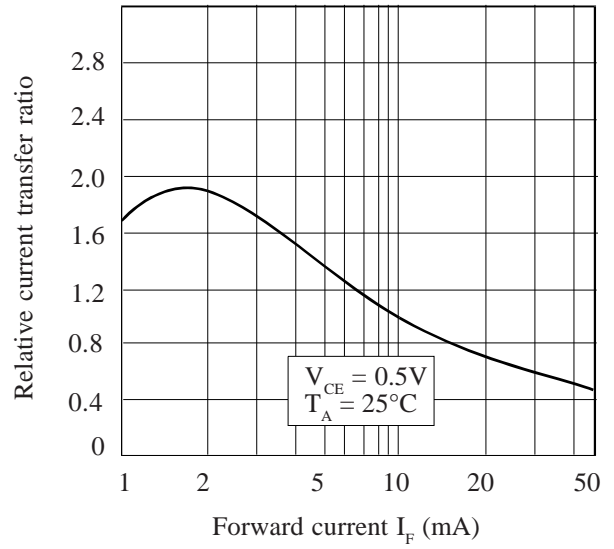

FIG 1

Collector Power Dissipation vs. Ambient Temperature



Relative Current Transfer Ratio vs. Forward Current



Forward Current vs. Ambient Temperature

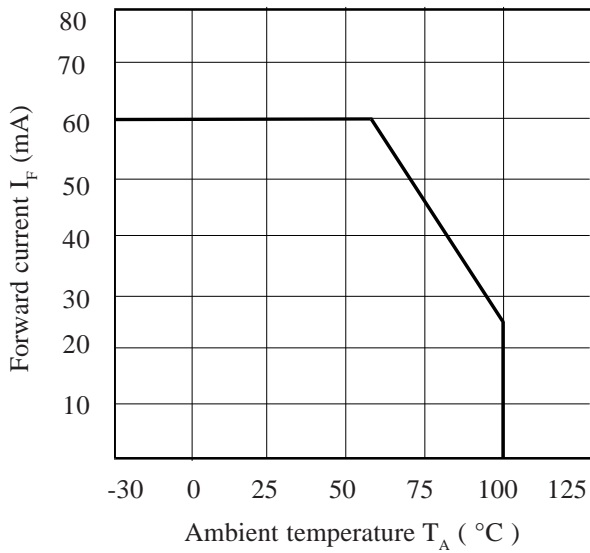

Relative Current Transfer Ratio vs. Forward Current

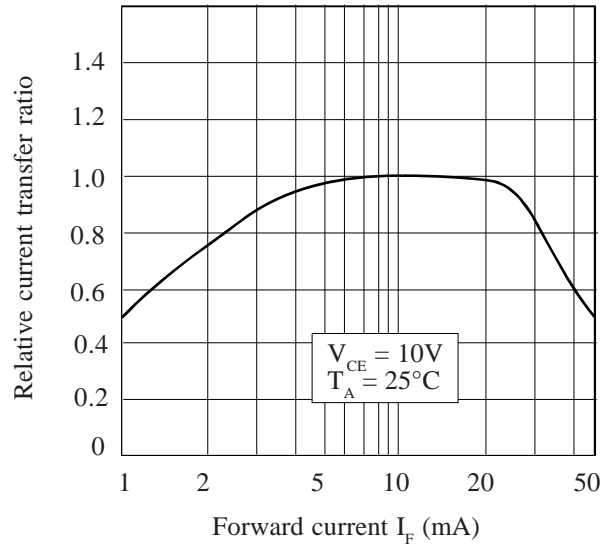

Relative Current Transfer Ratio vs. Ambient Temperature

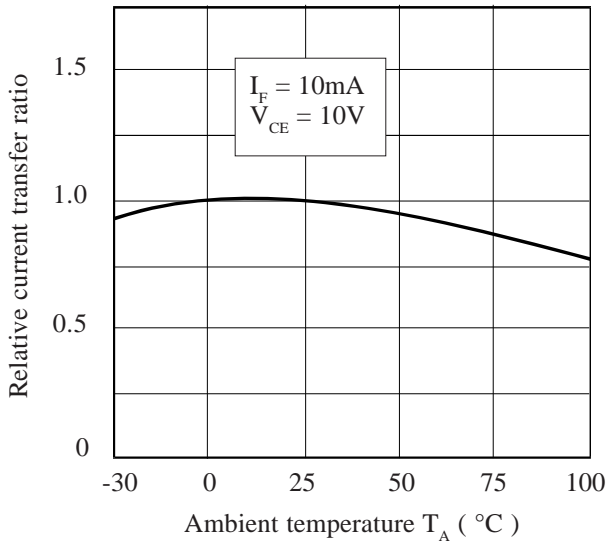

Collector-emitter Saturation Voltage vs. Ambient Temperature

